

PRODUCT DATASHEET

TR SP XR V 30W 924 24DEG WT BREAD

TRACKLIGHT SPECIAL FOOD LED | 3-phase tracklight spot with special LED



Areas of application

- Shops, supermarkets
- Food presentation in e.g. butchers, bakeries, supermarkets or meat processors
- Hotels, restaurants

Product benefits

- Specially tailored spectral distribution for food presentation only
- Reflector easily replaceable thanks to bayonet catch and rubber suction pad
- No distraction from the illuminated objects thanks to the reduced design
- Low flicker light thanks to special electronic control gear
- Good glare reduction ($UGR \leq 19$)

Product features

- Compact tracklight spot with in-track control gear
- Rotation angle: 350°, tilt angle: 90°
- Luminaire efficacy: up to 95 lm/W
- Color rendering index CRI 90
- Equipped with reflectors with 24° beam angle
- Durable die-cast aluminum housing
- Available in matt white (like RAL9003), matt black (like RAL9005)



TECHNICAL DATA

Electrical data

Nominal wattage	30.00 W
Nominal voltage	220...240 V
Mains frequency	50...60 Hz
Nominal current	750.000 mA
Inrush current	0.72 A
Inrush current time T_{h50}	51 μ s
Max. number of luminaires per miniature circuit breaker B16	94
Max. number of luminaires per miniature circuit breaker C10	58
Max. number of luminaires per miniature circuit breaker C16	94
Power factor λ	> 0.90
Total harmonic distortion	< 15 %
Protection class	II
Surge capability (L-N)	1000 V
Operating mode	Integrated LED driver

Photometrical data

Luminous flux	2100 lm
Luminous efficacy	70 lm/W
Color temperature	2400 K
Light color (designation)	Warm White
Color rendering index Ra	> 90
Standard deviation of color matching	<7 sdc _m
Luminous intensity	2500 cd
Low flicker	Yes
Flickering metric (Pst LM)	<1
Stroboscope effect metric (SVM)	<0.4
Photobiological safety group acc. to EN62778	RG1
Beam angle	15° / 24° / 36° / 50°
UGR	< 20

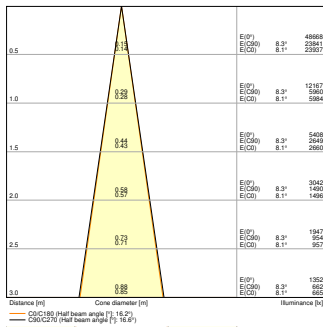

TR SP XR V 30W 924 BREAD WT
15D

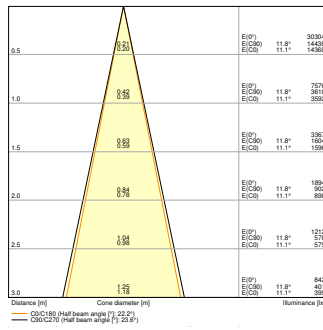

TR SP XR V 30W 924 BREAD WT
22.2D

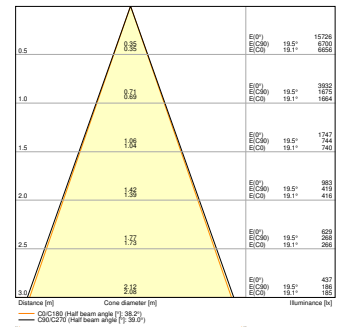

TR SP XR V 30W 924 BREAD WT
30.2D

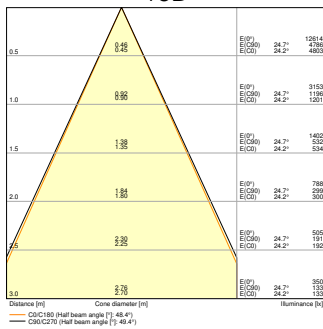

TR SP XR V 30W 924 BREAD WT
45.4D

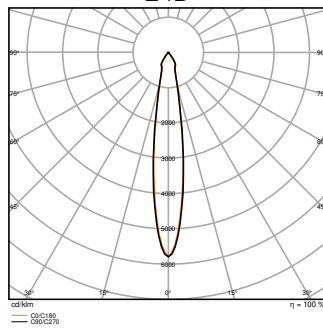

TR SP XR V 30W 924 BREAD WT
50D

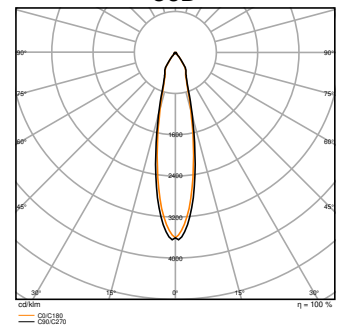

TR SP XR V 30W 924 BREAD WT
50D

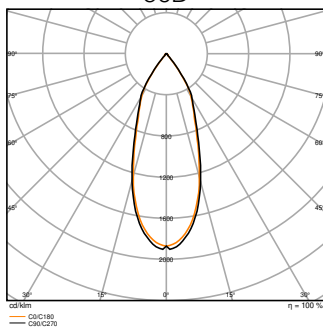

TR SP XR V 30W 924 BREAD WT
50D

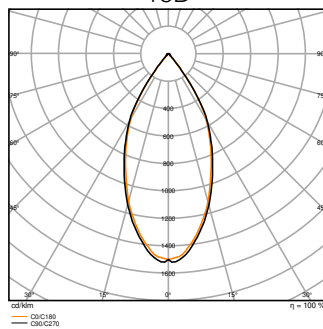

TR SP XR V 30W 924 BREAD WT
50D

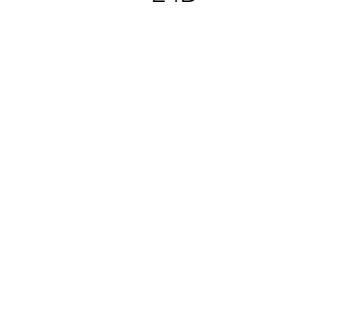

TR SP XR V 30W 924 BREAD WT
50D

Dimensions & Weight

Diameter	80.00 mm
Length	150.00 mm
Height	240.00 mm
Product weight	620.00 g

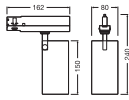

TR SP XR V 30W 24DEG

Materials & Colors

Product color	White
Housing color	White
Body material	Aluminum
Glow Wire Test according to IEC 60695-2-12	650 °C
Mercury content	0.0 mg

Application & Mounting

Ambient temperature range	-20...+40 °C
Temperature range at storage	-20...+80 °C
Type of connection	Adapter, 3-phase
Type of protection	IP20/IP20
Protection class IK (shock resistance)	IK02
Dimmable	No
Mounting type	Surface
Mounting location	Mounting track
Application environment	Indoor
Adjustable	Yes
With light source	Yes
Replaceable light source	No

Lifespan

Lifespan L70/B50 at 25 °C	50000 h ¹⁾
Number of switching cycles	25000

¹⁾ t[h]: L70 / B50 @ 25 °C (Ta), t[h]: L80 / B10 @ 25 °C (Ta), t[h]: L90 / B10 @ 25 °C (Ta)

Control gear

Output current	750 mA
ECG - Output ripple current	< 3 %

Emergency lighting

Type of emergency operation test	None
----------------------------------	------







Certificates & Standards





Standards	CE / ENEC / UKCA / EAC
Luminaire with limited surface temperature, "D sign"	No
Ball shot safe	No
Replaceable light source (EPREL)	Not replaceable

















Safety advice

- All electrical connections must be made by a qualified person.
- Caution, risk of electric shock.

DOWNLOAD DATA

	Documents and certificates	Document name
	User instruction / safety instructions	G11247140 TRACKLIGHT SPOT XR
	Legal information	Safety Insert G11218810
	Legal information	Informationstext 18 Abs 4 ElektroG
	Declarations of conformity	TRACKLIGHT SPOT
	Declarations of conformity UKCA	TRACKLIGHT SPOT
	Certificates	ENEC TR SP XR

	Photometric and lighting design files	Document name
	IES file (IES)	TR SP XR V 30W 924 BREAD WT 15D
	IES file (IES)	TR SP XR V 30W 924 BREAD WT 24D
	IES file (IES)	TR SP XR V 30W 924 BREAD WT 36D
	IES file (IES)	TR SP XR V 30W 924 BREAD WT 50D

Photometric and lighting design files		Document name
	LDT file (Eulumdat)	TR SP XR V 30W 924 BREAD WT 15D
	LDT file (Eulumdat)	TR SP XR V 30W 924 BREAD WT 24D
	LDT file (Eulumdat)	TR SP XR V 30W 924 BREAD WT 36D
	LDT file (Eulumdat)	TR SP XR V 30W 924 BREAD WT 50D
	UGR file (UGR table)	TR SP XR V 30W 924 BREAD WT 15D
	UGR file (UGR table)	TR SP XR V 30W 924 BREAD WT 24D
	UGR file (UGR table)	TR SP XR V 30W 924 BREAD WT 36D
	UGR file (UGR table)	TR SP XR V 30W 924 BREAD WT 50D
	Light distribution curve type cone	TR SP XR V 30W 924 BREAD WT 15D
	Light distribution curve type cone	TR SP XR V 30W 924 BREAD WT 24D
	Light distribution curve type cone	TR SP XR V 30W 924 BREAD WT 36D
	Light distribution curve type cone	TR SP XR V 30W 924 BREAD WT 50D
	Light distribution curve type polar	TR SP XR V 30W 924 BREAD WT 15D
	Light distribution curve type polar	TR SP XR V 30W 924 BREAD WT 24D
	Light distribution curve type polar	TR SP XR V 30W 924 BREAD WT 36D
	Light distribution curve type polar	TR SP XR V 30W 924 BREAD WT 50D
CAD/BIM files		Document name
	CAD STEP 3D	TL XR V 30W

LOGISTICAL DATA

Product code	Packaging unit (Pieces/Unit)	Dimensions (length x width x height)	Gross weight	Volume
4099854617089	Folding box 1	191 mm x 242 mm x 100 mm	766.00 g	4.62 dm ³
4099854617096	Shipping box 4	400 mm x 262 mm x 230 mm	3560.00 g	24.10 dm ³

The mentioned product code describes the smallest quantity unit which can be ordered. One shipping unit can contain one or more single products.

When placing an order, for the quantity please enter single or multiples of a shipping unit.

ADDITIONAL CATALOG INFORMATION

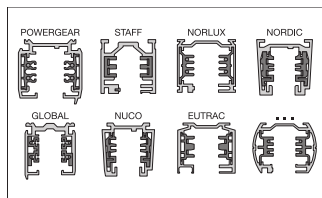
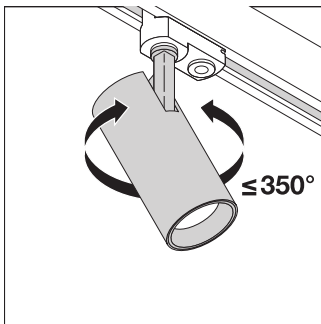
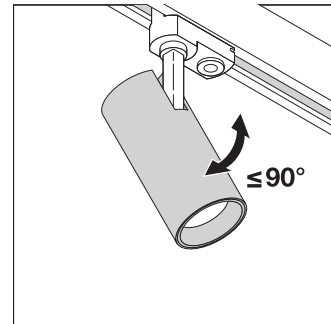
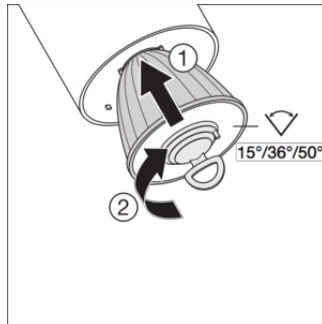
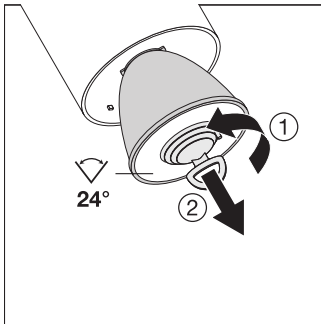

References / Links

– For Guarantee see www.ledvance.com/guarantee

DISCLAIMER

Subject to change without notice. Errors and omission excepted. Always make sure to use the most recent release.