

PRODUCT DATASHEET

SPOT FP FIX 7 W 3000 K IP65/IP20 WT

SPOT FIREPROOF | Recessed mounted spotlight, round shape, fire-resistant



GERMAN
DESIGN
AWARD
NOMINEE
2019



PERFOR-
MANCE
CLASS

Areas of application

- Replacement of halogen lamp spotlights
- Hotel rooms
- Bars, restaurants
- Bathrooms
- Accent lighting
- Galleries, museums
- General illumination
- Outdoor

Product benefits

- High luminous efficacy
- Design matches the LEDVANCE DOWNLIGHT luminaire family
- Energy savings of up to 90 % compared to halogen lamp spotlights
- Functional and minimalistic design
- Easy installation with fast connection
- External driver for extended flexibility (compatible with selected dim. drivers)
- Designed for extra IP protection
- 5 years guarantee

Product features

- Fire-resistant (up to 90 minutes, tested in accordance with EN 1365-2:2014 'fire resistance tests for loadbearing elements - Part 2: Floors and roofs')



- Outdoor use and fire-resistant (up to 90 minutes, BS476-20:1987 and BS476-21:1987)
- Compatible with standard ceiling cutouts of 68 mm
- Initial color consistency: ≤ 4 SDCM
- Type of protection, front side: IP65

TECHNICAL DATA**Electrical data**

Nominal wattage	7.00 W
Nominal voltage	220...240 V
Mains frequency	50...60 Hz
Nominal current	30 mA
Max. number of luminaires per miniature circuit breaker B16	32
Max. number of luminaires per miniature circuit breaker C10	25
Max. number of luminaires per miniature circuit breaker C16	40
Power factor λ	> 0.90
Total harmonic distortion	< 15 %
Protection class	II
Operating mode	Electronic control gear (ECG)

Photometrical data

Luminous flux	530 lm
Luminous efficacy	75 lm/W
Color temperature	3000 K
Light color (designation)	Warm White
Color rendering index Ra	> 80
Standard deviation of color matching	≤ 4 sdc _m
Photobiological safety group acc. to EN62778	RG0
Photobiological safety group acc. to EN62471	RG0
Beam angle	38 °

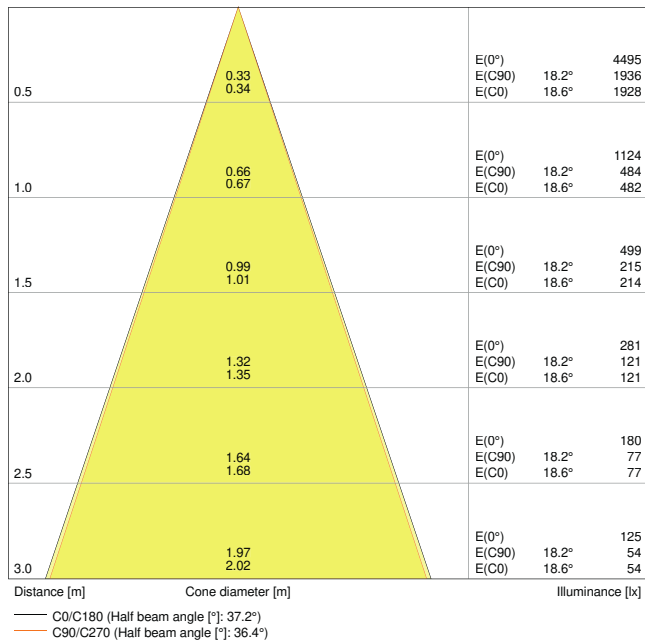

4058075000209 Spot-FP LED fix 7W 3000K 230V IP65

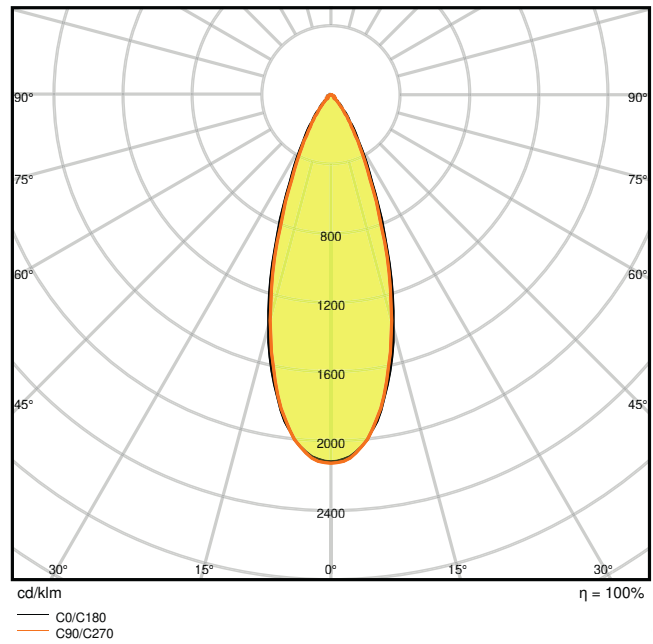

4058075000209 Spot-FP LED fix 7W 3000K 230V IP65

Dimensions & Weight

Diameter	90.00 mm
Height	72.00 mm
Product weight	289.00 g

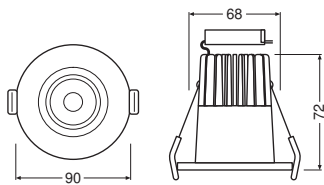

707988_LEDVANCE Spot-FP LED
fix 7W

Materials & Colors

Product color	White
Housing color	White
Body material	Aluminum
Light emitting surface material	PMMA

Glow Wire Test according to IEC 60695-2-12	650 °C
Mercury content	0.0 mg

Application & Mounting

Ambient temperature range	-20...+45 °C
Type of connection	Screw terminal, 2-Pole (L,N)
Type of protection	IP65/IP20
Protection class IK (shock resistance)	IK06
Dimmable	No
Mounting type	Recessed
Mounting location	Ceiling
Application environment	Indoor
Mounting diameter	68 mm
Mounting depth	90 mm
With light source	Yes
Replaceable light source	No

Lifespan

Lifespan L70/B50 at 25 °C	50000 h ¹⁾
Lifespan L80/B10 at 25 °C	40000 h ¹⁾
Lifespan L80/B50 at 25 °C	40000 h
Lifespan L90/B10 at 25 °C	20000 h
Number of switching cycles	100000

¹⁾ t[h]: L70 / B50 @ 25 °C (Ta), t[h]: L80 / B10 @ 25 °C (Ta), t[h]: L90 / B10 @ 25 °C (Ta)







Certificates & Standards







Standards	CE / CB / TÜV SÜD / EAC / RoHS
Luminaire with limited surface temperature, "D sign"	No
Ball shot safe	No
Replaceable light source (EPREL)	Not replaceable

Safety advice

– Coordination with your responsible fire safety inspector is required in advance

DOWNLOAD DATA

Documents and certificates		Document name
	User instruction / safety instructions	SPOT LED
	User instruction / safety instructions	714115_User Instruction SPOT LED
	On-Pack-Info	Legal Insert Spot LED
	Legal information	LSI SPOT LED ADJUST AND LED FIX
	Declarations of conformity	Attestation-of-Conformity-Spot LED -Fix-Adjust +Downlight LED TÜV
	Declarations of conformity UKCA	SPOT LED

Photometric and lighting design files		Document name
	IES file (IES)	Spot-FP LED fix 7W 3000K 230V IP65
	LDT file (Eulumdat)	Spot-FP LED fix 7W 3000K 230V IP65
	ULD file (DIALux)	SPOTFIREPROOF7W3000KIP65WT
	UGR file (UGR table)	4058075000209 Spot-FP LED fix 7W 3000K 230V IP65
	Light distribution curve type cone	4058075000209 Spot-FP LED fix 7W 3000K 230V IP65
	Light distribution curve type polar	4058075000209 Spot-FP LED fix 7W 3000K 230V IP65

LOGISTICAL DATA

Product code	Packaging unit (Pieces/Unit)	Dimensions (length x width x height)	Gross weight	Volume
4058075127333	Folding box 1	190 mm x 100 mm x 110 mm	398.00 g	2.09 dm ³
4058075190627	Folding box 1	190 mm x 100 mm x 110 mm	398.00 g	2.09 dm ³
4058075190634	Shipping box 20	525 mm x 400 mm x 250 mm	8720.00 g	52.50 dm ³
4058075127340	Shipping box 20	525 mm x 400 mm x 250 mm	8720.00 g	52.50 dm ³

The mentioned product code describes the smallest quantity unit which can be ordered. One shipping unit can contain one or more single products. When placing an order, for the quantity please enter single or multiples of a shipping unit.

ADDITIONAL CATALOG INFORMATION

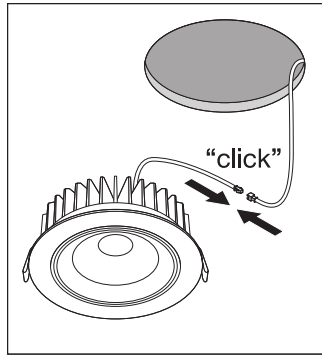
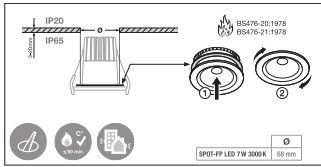

References / Links

– For Guarantee see www.ledvance.com/guarantee

DISCLAIMER

Subject to change without notice. Errors and omission excepted. Always make sure to use the most recent release.